

VOUMARD 1000

THE INNOVATIVE PLATFORM
CONCEPT FOR INTERNAL AND
EXTERNAL CYLINDRICAL GRINDING

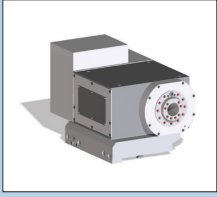

VOUMARD 1000



WORK HEAD WITH DIRECT DRIVE 200

- For high-precision cylindrical grinding
- Rotating speed 1-1,000 rpm
- Roundness accuracy <math>< 0.4 \mu\text{m}</math>
- Lower part with fine adjustment $\pm 0.01^\circ$

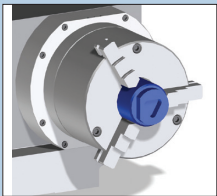

C-AXIS 200 (OPTIONAL)

- For non-circular workpieces
- For thread grinding

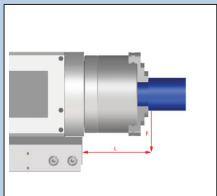

LOAD WITH CHUCKED WORK

- 320 Nm with direct drive

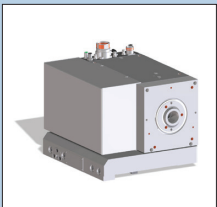

WORK HEAD WITH DIRECT DRIVE 50

- For high-precision cylindrical grinding
- Rotating speed 1-3,000 rpm
- Roundness accuracy <math>< 0.4 \mu\text{m}</math>
- Lower part with fine adjustment $\pm 0.01^\circ$

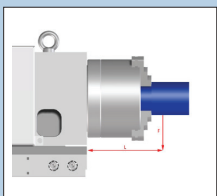

LOAD WITH CHUCKED WORK

- 100 Nm with direct drive



ONE-OF-A-KIND KINEMATICS

- Reduction to two highly accurate linear and rotational axes each with positioning in nanoscale
- No auxiliary axes are necessary for dressers or measuring systems
- C-axis for non-cylindrical workpieces and thread grinding
- Simplified set-up and increased accuracy
- A compact machine with a wide range of parts of up to $\varnothing 300 \times 300 \text{ mm}$

HYDROLIN® - HIGH-DYNAMICS HYDROSTATIC LINEAR AXES

- Positioning accuracy in nanoscale
- The wear-free linear motors feature integrated heat dissipation

BASIS

- FEM-optimized casting bed for high stability and durability
- Mechanical separation of machine and periphery for thermal stability and prevention of vibrations

THE ULTIMATE INTERPLAY OF PRECISION & PERFORMANCE



ERGONOMICS

- Optically and ergonomically advanced design
- Good overview of the grinding process
- Centrally arranged and easily accessible interfaces for table constructions
- Swivel- and height-adjustable control panel for optimized usability
- Well thought-out accessibility for inexpensive maintenance and service

CNC CONTROL 31i-B

- 19" LCD color screen with touch function
- BLUE Solution teach-programming with OBJECT Guide for guided and easy program creation on workpiece
- Windows 10 IoT IPC operating system
- A handheld device with security and setup functions
- Ethernet (RJ45) and USB 2.0 connection

HYDROSTATIC B-AXIS

- Fully-fledged NC axis
- Pre-stressed hydrostatic guidance
- Direct drive

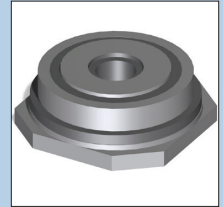

HYDROSTATIC X- / Z-AXIS

- Pre-stressed hydrostatic guidance
- No stick-slip, no wear
- The finest correction possibilities
- High form accuracy
- Direct drive

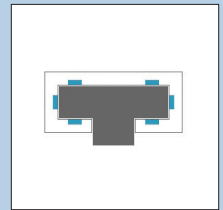

AUTOMATIC SLIDING DOOR

- Relief for the operator
- Faster workpiece changeover times

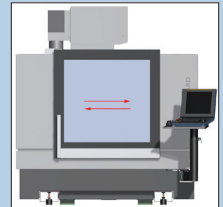

EASY TRANSPORTATION

- Forklift
- Hook lifting machine
- Fast and easy installation



AUTOMATION

- Profinet interface
- Loading cell with high autonomy
- Project-specific solutions on request

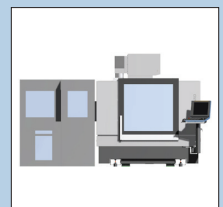

WORKPIECE HOLDER WITH DRESSING TURRET

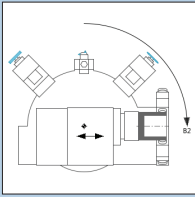

WORKPIECE CARRIER

- Work head
- Max. 3 dressers
- Steady rests
- Power clamping device
- B2-axis

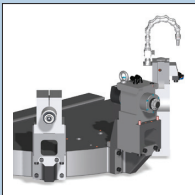

DRESSING UNITS

- Max. 3 dressers
- Up to 2 rotating dressers
- Firm dressing diamonds
- Form and profile rolls



STEADY RESTS

- Hydraulic steady rests
- 3-jaw steady rests

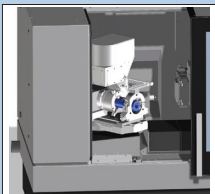

B2-AXIS

- Easy workpiece changeover
- Minimized dresser collision problematics
- Collision-free measuring position



INTEGRATED LIFTING SYSTEM

- Ergonomic Lifting system for table constructions

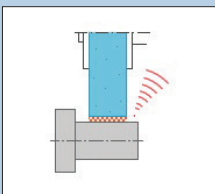

CONTACT SENSING

- Gap control with up to 4 sensors
- Operation and display integrated into the controller

WORKPIECE CARRIER

Various steady rests can be installed on the workpiece carrier, such as tracking hydraulic grinding steady rests. The integrated lifting system can be used for lifting table constructions. This saves the crane of the machine.

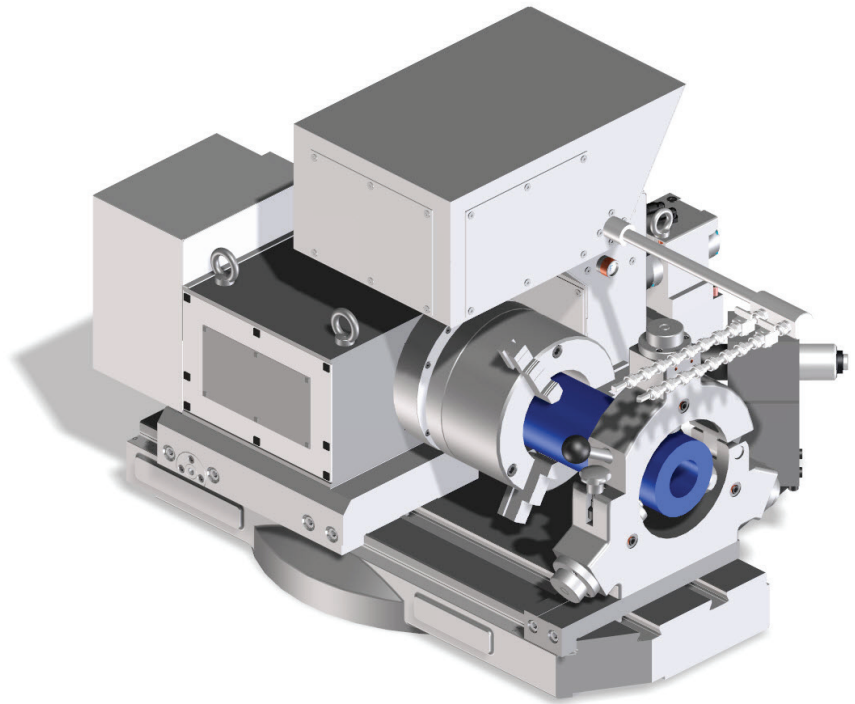

B2-AXIS ROTATING PART

An additional B2-axis can be added optionally on the workpiece carrier side. This offers the following advantages:

- Collision-free dressing
- Improved accessibility while measuring
- Easy workpiece changeover
- 3 dressing positions
- Automation of the loader system

The high-precision direct drive rotation axis can alternate between the grinding and dressing positions in < 2 seconds. The B2-axis has resolution of 1×10^{-8} degree and distortion-free clamping.

C-AXIS

With the possibility of X- and C-axis interpolation, VOUWARD 1000 allows grinding of non-cylindrical forms such as polygons, free contours and eccentrics. The rotary encoder with resolution of 1×10^{-7} degree is installed directly on the work head. The non-circular motion is superimposed onto the grinding motions, so that the grinding machine can fall back on any grinding cycle including handwheel release for the X-axis.

EXTERNAL & INTERNAL GRINDING / ROTATING PARTS / EQUIPMENT

WHEEL HEAD

The modular construction of the turret wheel head allows the 4 grinding spindle positions to be specified individually. The Internal grinding wheels measure up to max. \varnothing 150 x 40 mm. The external grinding wheels up to \varnothing 300 x 40 mm. Thanks to the flexible equipment, inside and outside diameters can be ground as well as flat surfaces.

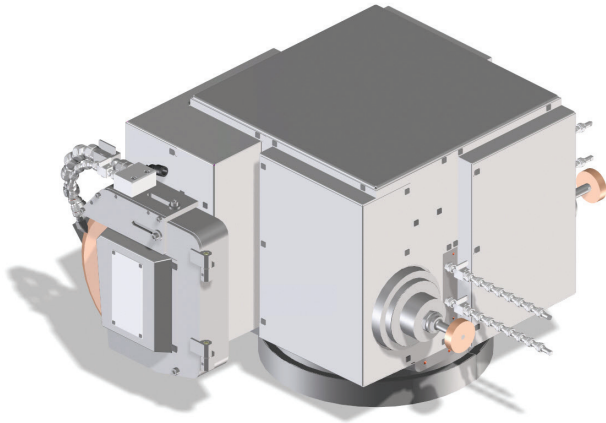

B1-AXIS ROTATING PART

A high-precision rotating axis is installed for faster positioning of the wheel head. Workpiece changeover lasts < 2.5 seconds. The B1-axis with direct drive has a resolution of 1×10^{-8} degree and distortion-free clamping.

With the B1-axis, up to 4 grinding spindle positions can be swiveled to the grinding position. Additionally, a fixed tactile measuring probe attached to the base body can be used for measurement tasks. The tactile measuring probe can measure internal and external diameters, shoulder positions and shoulder distances.

WORKPIECE MEASUREMENT SYSTEM

Automatic grinding wheel measurement. When swiveling the wheel head into the desired angular positions, the positions of the grinding wheel edges are automatically calculated. This offers the following advantages for the user:

- Programming with the effective masses according to the workpiece drawing and regardless of the swivel angle of the wheel head
- Renewed calibration of the swiveled grinding wheel is not required
- Simple and quick recording of the grinding wheel data when re-equipping the machine
- Workpiece management for external, surface and internal grinding is already integrated

TURRET WHEEL HEAD

- Individually configurable
- Compact
- 4 spindle positions
- FEM optimization
- Aluminum cooling-line

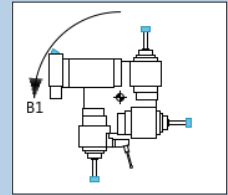

INTERNAL GRINDING EQUIPMENT

- Oil-air lubricated HF internal grinding spindle of max. 120,000 rpm (depending on the spindle)
- Powerful and universal
- With or without process coolant through internal grinding spindle
- Grinding wheel measurements up to \varnothing 150 x 40 mm

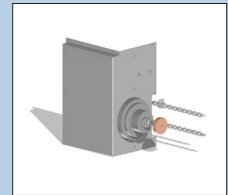

EXTERNAL GRINDING EQUIPMENT

- External grinding with water-cooled motor spindles and 12.7 kW performance
- Oil-air lubrication guarantees long durability
- Grinding wheel measurements up to \varnothing 300 x 40 mm

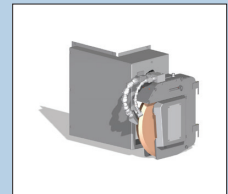

TACTILE MEASURING HEAD

- Mounted on the wheel head
- Orientation of the workpiece position in X-, Z- and C-position
- Active measurement of the diameter and length

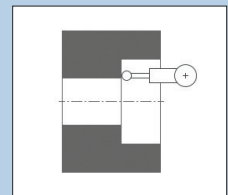

BALANCING

- Mounted on the wheel head

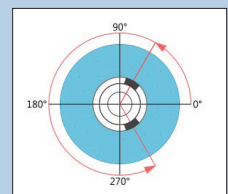

FANUC CONTROLLER 3i – WITH KELLENBERGER HMI

The **BLUE Solution interface** from KELLENBERGER has a central focus on productive and flexible operation. All interactions are carried out by gestures on the 19" touch display. The latest generation of a reliable FANUC 3i controller runs in the background.

BLUE SOLUTION



The user interface was developed explicitly for grinding by our specialists in cooperation with customers. BLUE Solution supports users regardless of their level of experience in all important steps from setup to production.

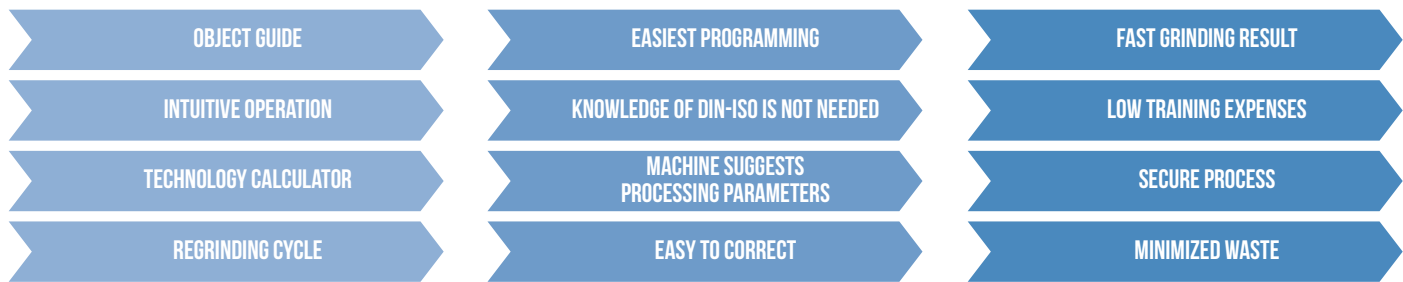

BLACK CAM SOLUTION

NC programs for grinding and non-cylindrical grinding, grinding and truing of profiles and screw threads can be generated, simulated and analyzed with the additional BLACK CAM Solution software. The CAD-CAM software supports the structured creation, processing and management of all documents belonging to a workpiece.



INDUSTRY 4.0

The Security Interface ensures communication between the machine and the production network according to the highest IT security standard.

The optional Remote Diagnostic module facilitates efficient diagnosis in service cases and thus reduces downtimes. The machine is ready for Industry 4.0. With the ComGateway, which has a standard OPC-UA server, extensive information on process and machine status can be exchanged.

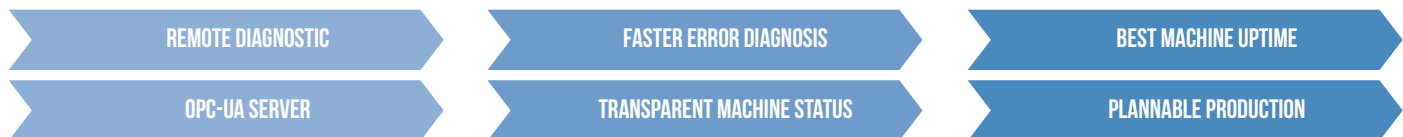

Characteristics		
Max. workpiece length	300	mm
Swing diameter	<300	mm
Max. workpiece diameter	<150 / <300	mm
Supply voltage	400 / 460	V
Power consumption	35 - 80	A
Atmospheric pressure	5.5	bar
Total weight	5'800	kg
Floor loading	8'100	N/m ²
X- / Z-axis		
Travel	450	mm
Speed	<20	m/min
Resolution	2.5 x 10 ⁻⁶	mm
B axis		
Instrument swivel range	330	°
Workpiece swivel range	225	°
Resolution	1 x 10 ⁻⁸	°
Turret wheel head		
Rotational speed range (depending on the spindle)	<120'000	rpm
Max. number of spindles	4	-
Peripheral speed	50	m/s
Internal grinding wheel	max. 150x40	mm
Max. internal grinding length	250	mm
Mounting hole of the internal grinding spindle	150	mm
External grinding wheel	300x40	mm
Max. external grinding length	150	mm
Work head		
	Work head 200	Work head 50
Rotational speed range	I-1000	I-1500 / I-3000
Mounting cone	MK5	MK4
External short taper adapter	ISO 702-I: Size 5	ISO 702-I: Gr. 3
Workpiece weight	< 200	<50 / < 20
Load on chucked work	< 320	< 100
Resolution	1 x 10 ⁻⁷	-
CNC controller		
FANUC	FANUC 31i-B	-

Information on dimensions, weight and construction is subject to changes

SETUP PLAN 300

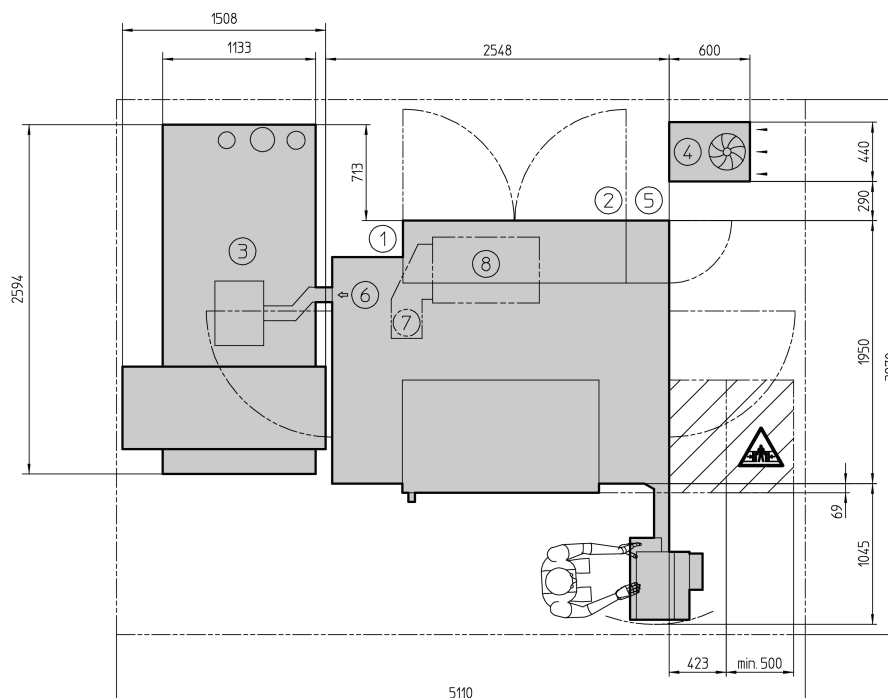

HARDINGE WORLDWIDE

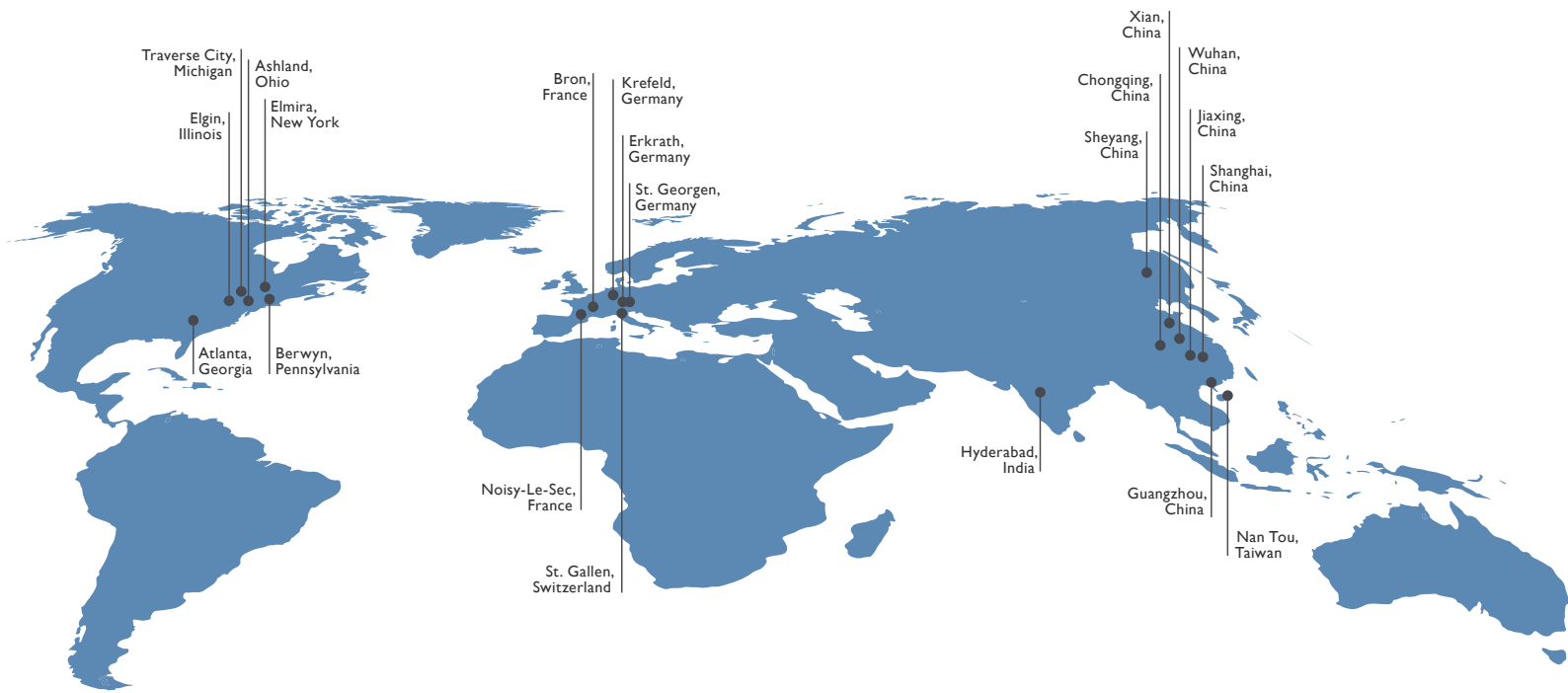

Hardinge is a leading international provider of advanced metal-cutting solutions. We provide a full spectrum of highly reliable CNC turning, milling, grinding, and honing machines as well as technologically advanced workholding accessories.

The diverse products we offer enable us to support a variety of market applications in industries including aerospace, agricultural, automotive, construction, consumer products, defense, energy, medical, technology, transportation and more.

We've developed a strong global presence with manufacturing operations in North America, Europe, and Asia. Hardinge applies its engineering and applications expertise to provide your company with the right machine tool solution and support every time.

AMERICAS

GEORGIA
Hardinge Corporate
79 W Paces Ferry Rd, 2F
Atlanta, GA 30305
P. 800.843.8801

ILLINOIS
Hardinge
1755 Britannia Dr
Unit 1A
Elgin, IL 60124

MICHIGAN
Forkardt
2155 Traversefield Dr
Traverse City, MI 49686
P. 800.544.3823
E. tcsales@forkardt.com

NEW YORK
Hardinge
1 Hardinge Drive
Elmira, NY 14903
P. 800.843.8801
E. info@hardinge.com

OHIO
Ohio Tool Works
1374 Enterprise Parkway (TR 743)
Ashland, OH 44805
P. 419.281.3700
E. sales@ohiotoolworks.com

PENNSYLVANIA
Hardinge
1235 Westlakes Drive
Suite 410
Berwyn, PA 19312

ASIA
CHINA
Hardinge Machine
(Shanghai) Co. Ltd.
1388 East Kangqiao Road
Pudong, Shanghai 201319
P. 0086 21 3810 8686

TAIWAN
Hardinge Machine Tools
B.V., Taiwan Branch
No.11,Tzu Li 3rd Rd.,
Nantou City, 540 Taiwan
P. 886 49 2260 536
E. cs@hardinge.com.tw

EUROPE

SWITZERLAND
L. Kellenberger & Co. AG
Heiligkreuzstrasse 28
CH 9008 St. Gallen
Switzerland
P. 41 71 2429111
E. info@kellenberger.net

GERMANY
Hardinge GmbH
Fichtenhain A 13c
47807 Krefeld
P. 49 2151 49649 10
E. info@hardinge-gmbh.de

J.G. Weisser Söhne GmbH
Johann-Georg-Weisser-Straße 1
78112 St. Georgen
P. +49 7724 881-0
E. info@weisser-web.com

FRANCE
Jones & Shipman SARL
8 Allée des Ginkgos
BP 112-69672
Bron Cedex, France

HARDINGE.COM | SHOP.HARDINGE.COM

800-843-8801 • info@hardinge.com • parts@hardinge.com • service@hardinge.com

All prices and specifications are subject to change without notice. All marks indicated by ® and ™ are trademarks of their respective owners.
#1213_Voumard1000 in USA © Hardinge Inc. 2022 • 08/2022